

36V, 4A Synchronous Step-Down LED Driver with Silent Switcher

FEATURES

- $\pm 1.5\%$ LED Current Regulation
- $\pm 1.2\%$ Output Voltage Regulation
- Spread-Spectrum Frequency Modulation
- Silent Switcher® Architecture for Low EMI
- 3.6V to 36V Input Voltage Range
- 0V to 36V LED String Voltage
- 200kHz to 2MHz with SYNC Function
- 20:1 Analog or Duty Cycle LED Current Control
- Open/Short LED Fault Indication
- Accurate LED Current Sense with Monitor Output
- Programmable UVLO
- Thermally Enhanced 28-Lead (5mm × 4mm) LQFN

APPLICATIONS

- Automotive Lighting
- Industrial and General Purpose Lighting

DESCRIPTION

The **LT®3935** is a monolithic, synchronous, step-down DC/DC converter that utilizes fixed-frequency, peak current control and provides PWM dimming for a string of LEDs. The LED current is programmed by an analog voltage or the duty cycle of pulses at the CTRL pin. An output voltage limit can be set with a resistor divider to the FB pin.

The switching frequency is programmable from 200kHz to 2MHz by an external resistor at the RT pin or by an external clock at the SYNC/SPRD pin. With the optional spread spectrum frequency modulation enabled, the frequency varies from 100% to 125% to reduce EMI.

Additional features include an LED current monitor, an accurate EN/UVLO pin threshold, open-drain fault reporting for open-circuit and short-circuit load conditions, and thermal shutdown. The LT3935 utilizes proprietary Silent Switcher technology for very low EMI.

All registered trademarks and trademarks are the property of their respective owners. Protected by U.S. Patents including 7199560, 7321203, 9596728, 9642200 and other patents pending.

TYPICAL APPLICATION

4A LED Driver with Fault Indication

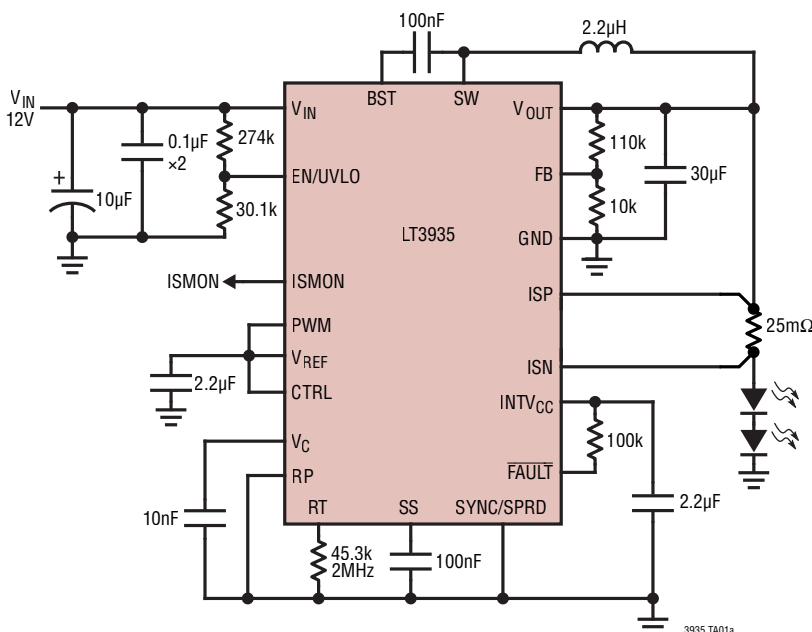

Efficiency vs V_{IN}

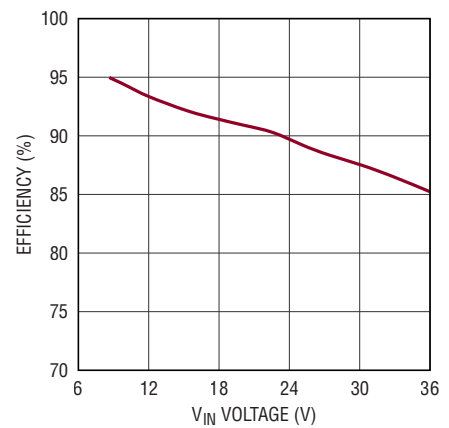

LT3935

ABSOLUTE MAXIMUM RATINGS

(Note 1)

V_{IN} , EN/UVLO.....	-0.3V to 40V
ISP, ISN, and V_{OUT}	-0.3V to 40V
ISP – ISN	$\pm 0.3V$
CTRL and FB	-0.3V to 3.3V
PWM, SYNC/SPRD, and \overline{FAULT}	-0.3V to 6V
SS and V_C	-0.3V to 3.3V
SW, BST, INTV _{CC} , V_{REF} , ISMON, RT, and RP	(Note 2)
Operating Junction Temperature Range (Notes 3, 4)	
LT3935R	-40°C to 150°C
Storage Temperature Range	-65°C to 150°C
Maximum Reflow (Package Body) Temp	260°C

PIN CONFIGURATION

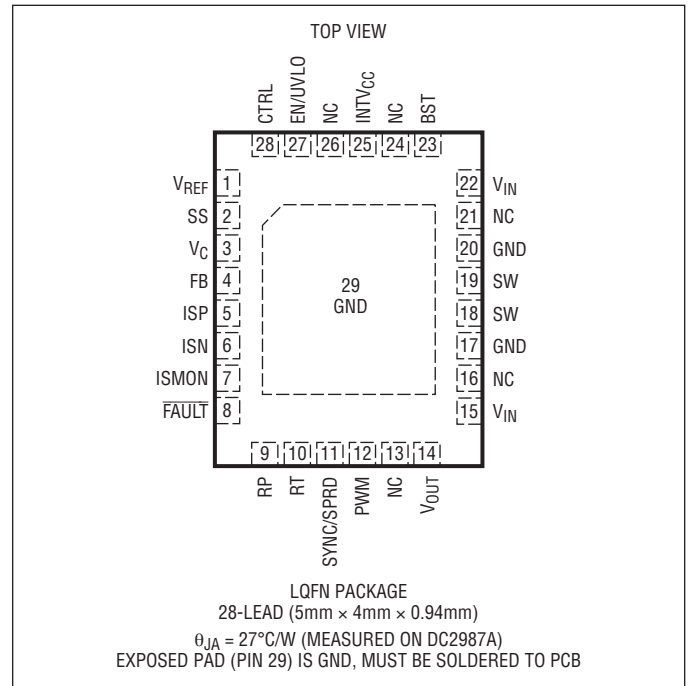

ORDER INFORMATION

PART NUMBER	PART MARKING	FINISH CODE	PAD FINISH	PACKAGE TYPE*	MSL RATING	TEMPERATURE RANGE
LT3935RV#PBF	3935V	e4	Au(RoHS)	LQFN (Laminate Package with QFN Footprint)	3	-40°C to 150°C

- Contact the factory for parts specified with wider operating temperature ranges.
 - Pad finish code is per IPC/JEDEC J-STD-609.
 - Parts ending with PBF are RoHS and WEEE compliant.
 - [Recommended LGA and BGA PCB Assembly and Manufacturing Procedures](#)
 - [LGA and BGA Package and Tray Drawings](#)
- *The LT3935 package has the same footprint as a standard 4mm × 5mm QFN package

ELECTRICAL CHARACTERISTICS The ● denotes the specifications which apply over the full operating temperature range, otherwise specifications are at $T_A = 25^\circ\text{C}$. $V_{IN} = 12\text{V}$, $V_{EN/UVLO} = 5\text{V}$ unless otherwise noted.

PARAMETER	CONDITIONS		MIN	TYP	MAX	UNITS
Input Voltage Range			3.6		36	V
V_{IN} Pin Quiescent Current	EN/UVLO = 2V, Not Switching EN/UVLO = 300mV, Shutdown	●		2.7	3.3 16	mA μA
EN/UVLO Threshold (Falling)			1.09	1.16	1.23	V
EN/UVLO Rising Hysteresis				20		mV
EN/UVLO Pin Hysteresis Current				4		μA
Reference						
V_{REF} Voltage	$I_{VREF} = 0\mu\text{A}$ $I_{VREF} = 500\mu\text{A}$	●	1.975 1.980	2 1.998	2.020 2.016	V V
V_{REF} Pin Current Limit	$V_{REF} = 1.9\text{V}$, Current Out of Pin			2		mA
LED Current Regulation						
CTRL-Off Threshold (Falling)		●	200	218	233	mV
CTRL-Off Rising Hysteresis				20		mV
CTRL Pin Current	$V_{CTRL} = 2\text{V}$		-100		100	nA
Sense Voltage ($V_{ISP}-V_{ISN}$) (Analog Input)	$V_{CTRL} = 2\text{V}$ (100%), $V_{IN} = 36\text{V}$, $V_{ISP} = 24\text{V}$ $V_{CTRL} = 750\text{mV}$ (50%), $V_{IN} = 36\text{V}$, $V_{ISP} = 24\text{V}$ $V_{CTRL} = 300\text{mV}$ (5%), $V_{IN} = 36\text{V}$, $V_{ISP} = 24\text{V}$	● ● ●	98.5 48.5 4	100 50 5	101.5 51.5 6	mV mV mV
ISP Pin Current	$V_{IN} = 36\text{V}$, $V_{ISP} = 24\text{V}$, $V_{CTRL} = 2\text{V}$, Current Into Pin			50		μA
ISN Pin Current	$V_{IN} = 36\text{V}$, $V_{ISN} = 24\text{V}$, $V_{CTRL} = 2\text{V}$, Current Into Pin			50		μA
ISP/ISN Common Mode Range	$V_{IN} = 36\text{V}$ (Note 5)		0		36	V
Current Error Amplifier Transconductance	$V_{IN} = 36\text{V}$, $V_{ISP} = 24\text{V}$			200		$\mu\text{A/V}$
Duty Cycle Control of LED Current						
Sense Voltage ($V_{ISP}-V_{ISN}$) (Duty Cycle Input)	CTRL Duty = 75% (100%), $V_{IN} = 12\text{V}$, $V_{ISP} = 10\text{V}$ CTRL Duty = 37.5% (50%), $V_{IN} = 12\text{V}$, $V_{ISP} = 10\text{V}$ CTRL Duty = 15% (5%), $V_{IN} = 12\text{V}$, $V_{ISP} = 10\text{V}$		99 49 4	100 50 5	101 51 6	mV mV mV
CTRL Pulse Input High (V_{IH})			1.6			V
CTRL Pulse Input Low (V_{IL})					0.4	V
CTRL Pulse Input Frequency Range			100		1000	kHz
Voltage Regulation						
FB Regulation Voltage	$V_{ISP} = V_{ISN} = 6\text{V}$, $V_{CTRL} = 2\text{V}$	●	0.988	1.000	1.012	V
FB Pin Current	$V_{FB} = 1\text{V}$		-100		100	nA
Voltage Error Amplifier Transconductance				480		$\mu\text{A/V}$
Power Stage						
Peak Current Limit			5.6	6.8	7.9	A
Minimum Off-Time	(Note 6)			55		ns
Minimum On-Time	(Note 6)			55		ns
Bottom Switch On-Resistance				40		$\text{m}\Omega$
Top Switch On-Resistance				40		$\text{m}\Omega$
Oscillator						
Programmed Switching Frequency (f_{SW})	$R_T = 45.3\text{k}$, $V_{SYNC/SPRD} = 0\text{V}$ $R_T = 523\text{k}$, $V_{SYNC/SPRD} = 0\text{V}$	● ●	1890 180	2000 200	2150 230	kHz kHz
Spread Spectrum Frequency Range	$R_T = 45.3\text{k}$, $V_{SYNC/SPRD} = 3.3\text{V}$ $R_T = 523\text{k}$, $V_{SYNC/SPRD} = 3.3\text{V}$		1890 180		2700 290	kHz kHz

ELECTRICAL CHARACTERISTICS

The ● denotes the specifications which apply over the full operating temperature range, otherwise specifications are at $T_A = 25^\circ\text{C}$. $V_{IN} = 12\text{V}$, $V_{EN/UVLO} = 5\text{V}$ unless otherwise noted.

PARAMETER	CONDITIONS	MIN	TYP	MAX	UNITS	
RT Pin Current Limit	$V_{RT} = 0\text{V}$, Current Out of Pin		34		μA	
SYNC/SPRD Threshold		1		2	V	
SYNC/SPRD Pin Current	$V_{\text{SYNC/SPRD}} = 3.3\text{V}$	-100		100	nA	
Soft-Start						
SS Pin Charging Current	$V_{SS} = 0\text{V}$		20		μA	
SS Pin Discharging Current	$V_{SS} = 2\text{V}$		1.25		μA	
SS Lower Threshold (Falling)			200		mV	
SS Higher Threshold (Rising)			1.7		V	
Fault Detection						
Open-Circuit Threshold (FB Rising)		●	930	950	975	mV
Open-Circuit Falling Hysteresis			55			mV
Short-Circuit Threshold (FB Falling)		●	180	200	220	mV
Short-Circuit Rising Hysteresis			50			mV
FAULT Pull-Down Current	$V_{\text{FAULT}} = 200\text{mV}$, $V_{\text{FB}} = 0\text{V}$		100			μA
FAULT Leakage Current	$V_{\text{FAULT}} = 3.3\text{V}$, $V_{\text{FB}} = 700\text{mV}$		-100		100	nA
Overvoltage Protection						
FB Overvoltage Threshold (FB Rising)			1.050			V
FB Overvoltage Falling Hysteresis			48			mV
LED Current Monitor						
ISMON Voltage	$V_{\text{ISP}} - V_{\text{ISN}} = 100\text{mV}$ (100%), $V_{\text{ISP}} = 12\text{V}$ $V_{\text{ISP}} - V_{\text{ISN}} = 10\text{mV}$ (10%), $V_{\text{ISP}} = 12\text{V}$	0.950	1.000	1.030	V	
		80	100	120	mV	
PWM Driver						
PWM Threshold (Rising)	$V_{\text{OUT}} = 12\text{V}$		1.7		V	
PWM Pin Current	$V_{\text{PWM}} = 2\text{V}$		-100		100	nA
RP Pin Current Limit	$R_P = 0\text{V}$, Current Out of Pin		60		μA	

Note 1: Stresses beyond those listed under Absolute Maximum Ratings may cause permanent damage to the device. Exposure to any Absolute Maximum Rating condition for extended periods may affect device reliability and lifetime.

Note 2: Do not apply a positive or negative voltage source to these pins, otherwise permanent damage may occur.

Note 3: Specifications over the -40°C to 125°C operating junction temperature range are assured by design, characterization and correlation with statistical process controls. The The LT3935R is guaranteed over the -40°C to 150°C operating junction temperature range. Operating lifetime is derated for junction temperatures greater than 125°C .

Note 4: This IC includes overtemperature protection that is intended to protect the device during momentary overload conditions. The maximum rated junction temperature will be exceeded when this protection is active. Continuous operation above the specified absolute maximum operating junction temperature may impair device reliability or permanently damage the device.

Note 5: The current sense error amplifier is tested with $V_{\text{ISP}} = 36\text{V}$, and separately, with $V_{\text{ISN}} = 0\text{V}$.

Note 6: The MIN on and off times are guaranteed by design and are not tested.

TYPICAL PERFORMANCE CHARACTERISTICS

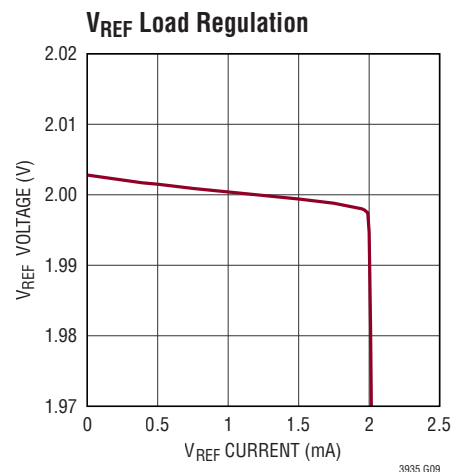
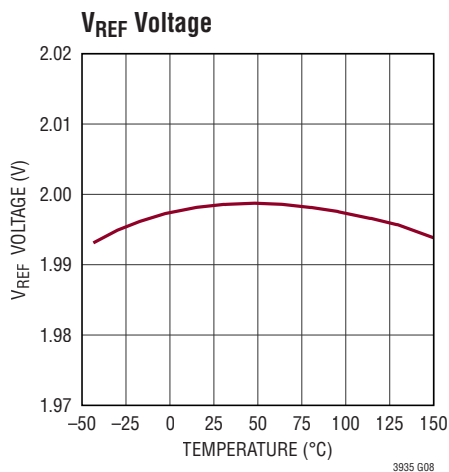
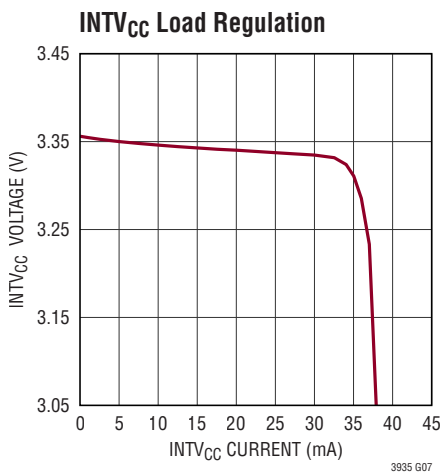
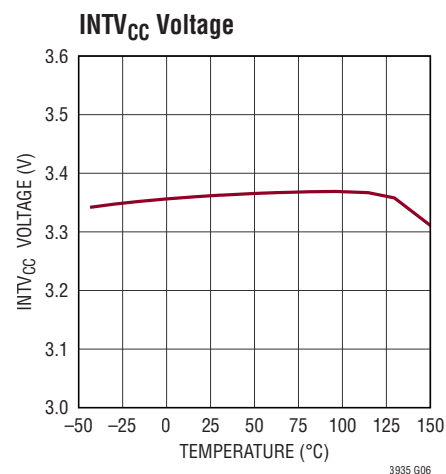
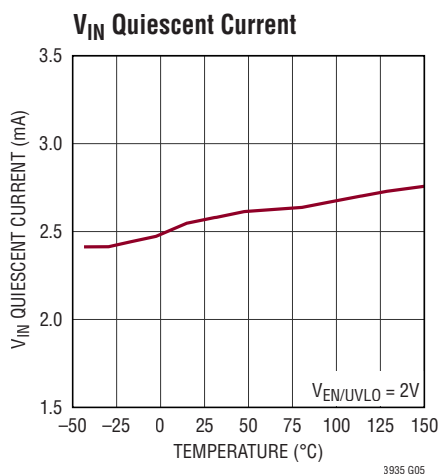
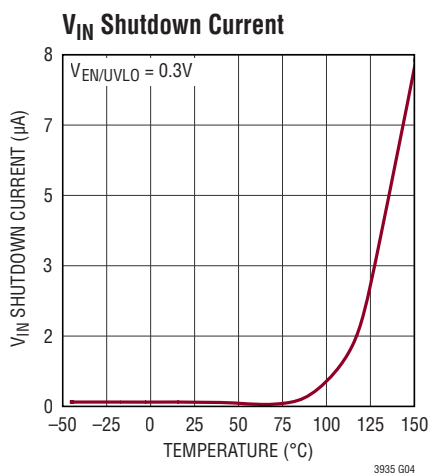
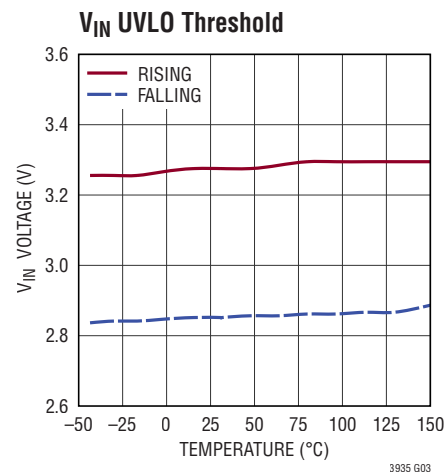
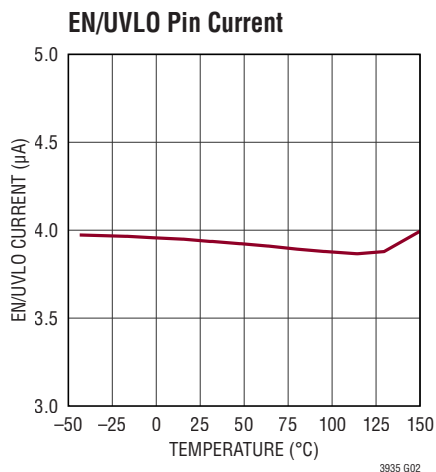
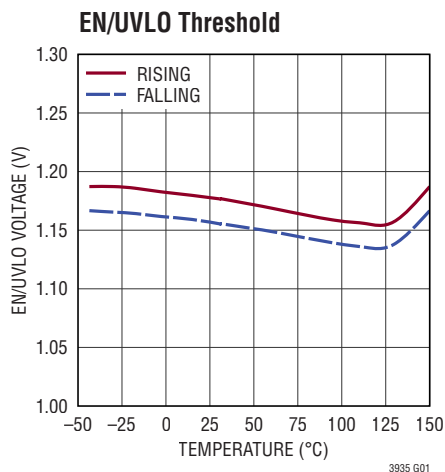

TYPICAL PERFORMANCE CHARACTERISTICS

V_{REF} Line Regulation

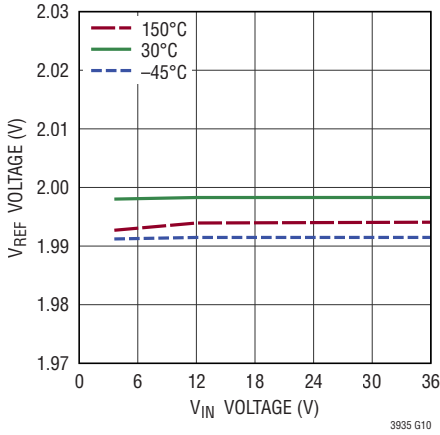

3935 G10

INTV_{CC} and V_{REF} UVLO Falling Threshold

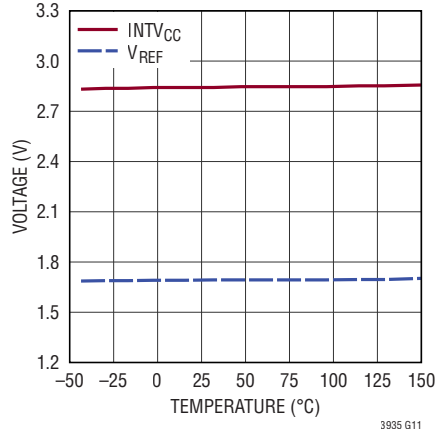

3935 G11

SW Frequency

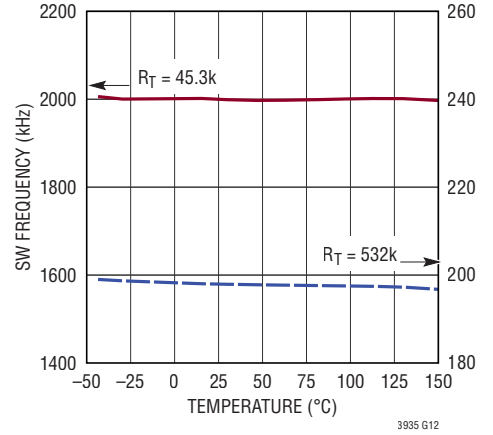

3935 G12

RP and RT Pin Current Limit

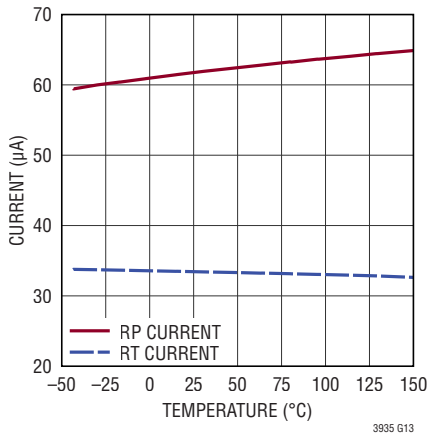

3935 G13

SS Pin Pull-Up Current

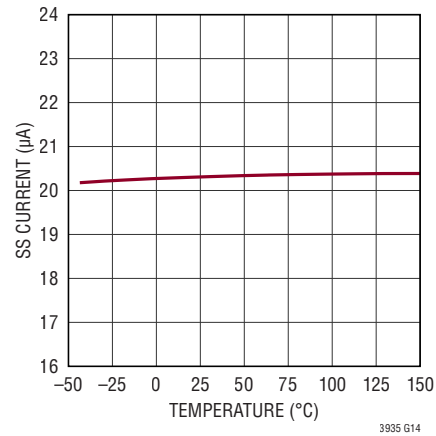

3935 G14

SS Threshold

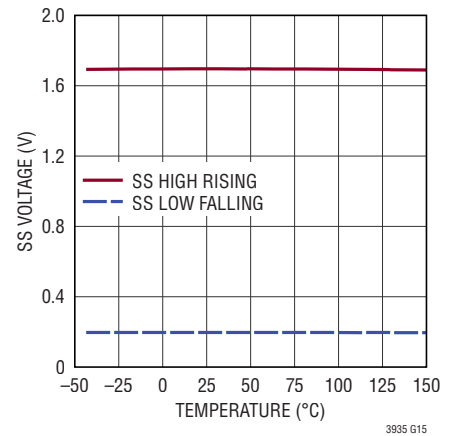

3935 G15

Peak SW Current Limit

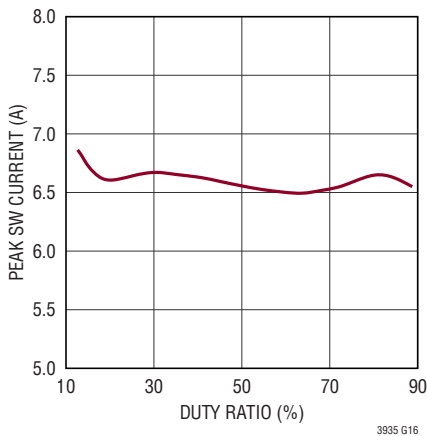

3935 G16

Peak Current vs Temperature

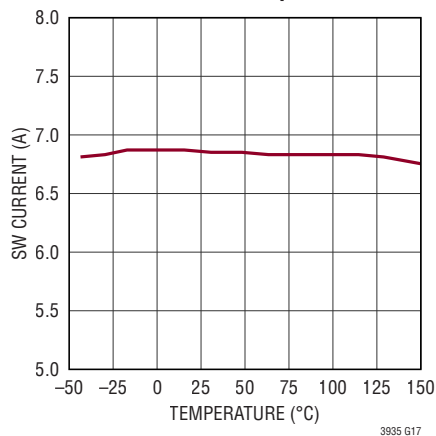

3935 G17

Power Switch On-Resistance

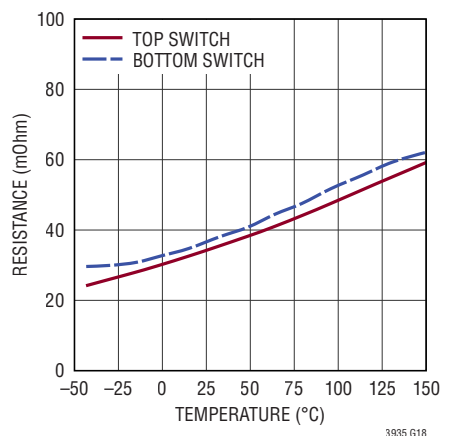

3935 G18

TYPICAL PERFORMANCE CHARACTERISTICS

LED Current (Analog CTRL)

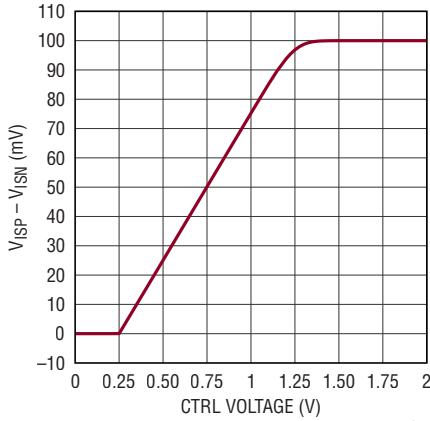

3935 G19

LED Current (Digital CTRL)

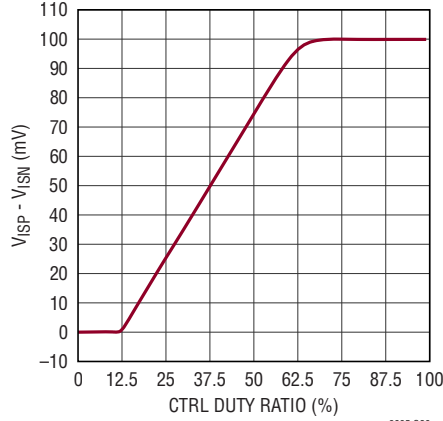

3935 G20

LED Voltage Limit

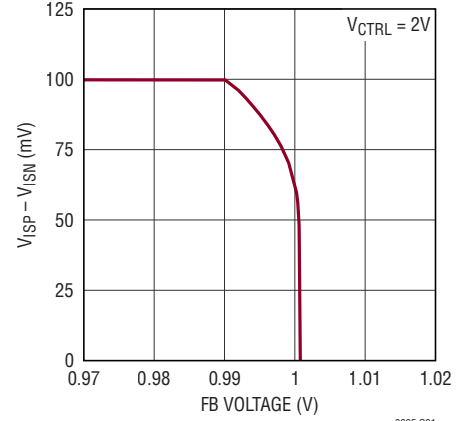

3935 G21

LED Current (100% Regulation)

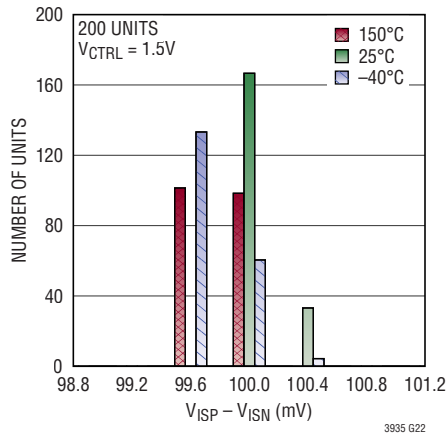

3935 G22

LED Current (5% Regulation)

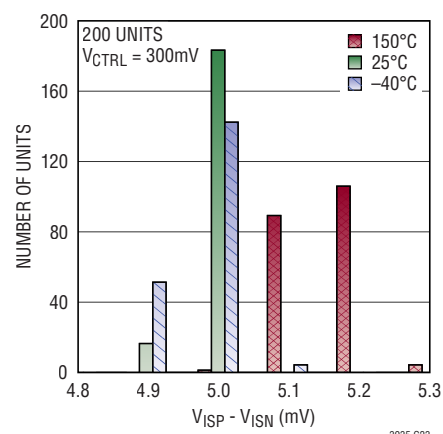

3935 G23

ISMON Voltage

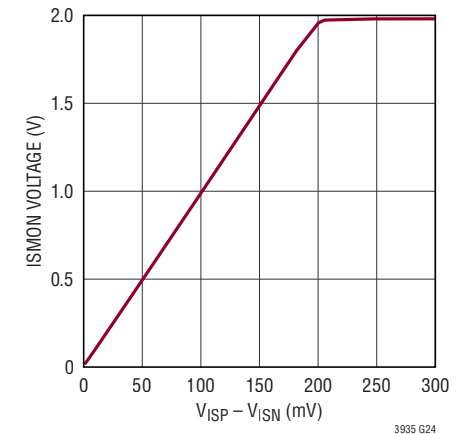

3935 G24

C/10 Threshold

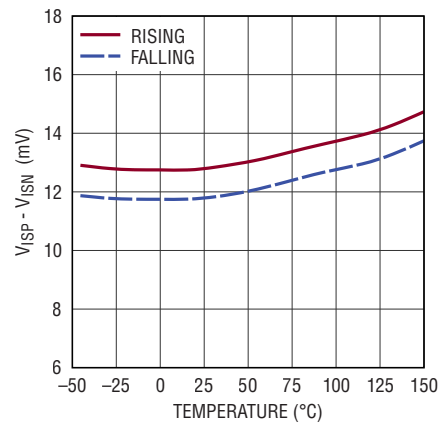

3935 G25

LED Current vs V_{IN}

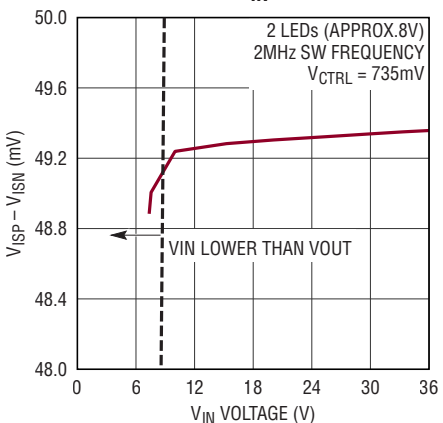

3935 G26

LED Current vs V_{OUT}

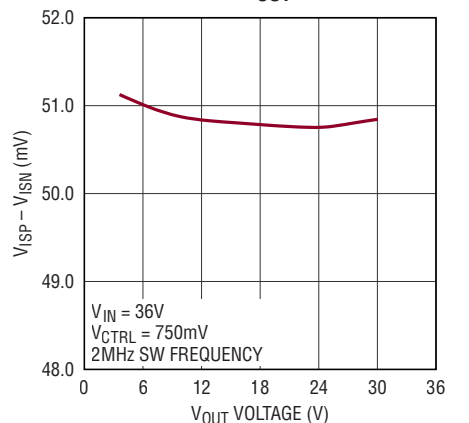

3935 G27

TYPICAL PERFORMANCE CHARACTERISTICS

FB OPENLED Threshold

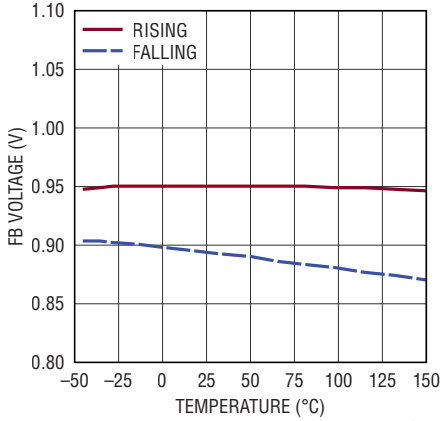

3935 G28

FB SHORTLED Threshold

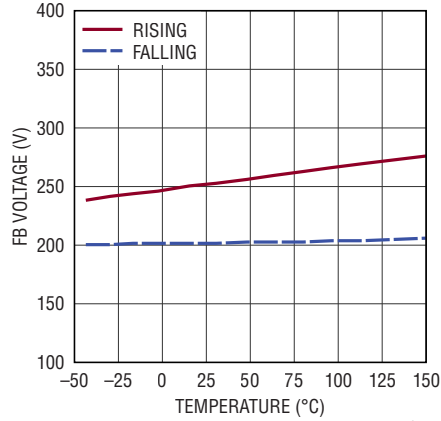

3935 G29

FB OVLO Threshold

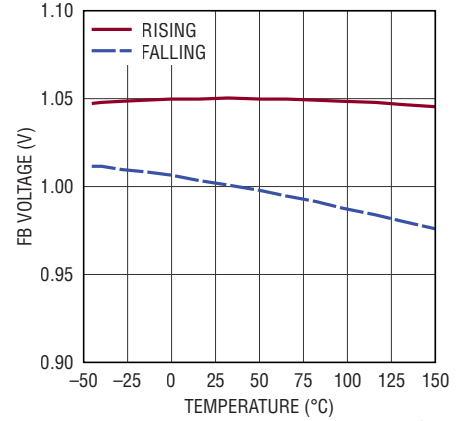

3935 G30

Efficiency vs V_{IN}

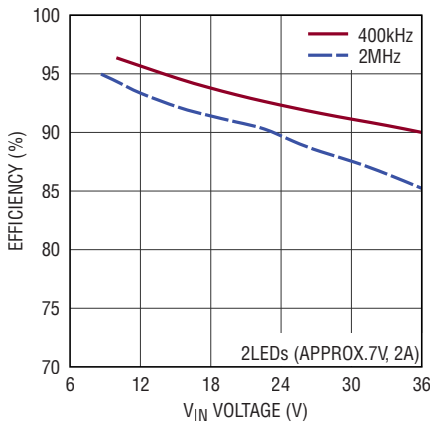

3935 G31

Efficiency vs I_{LED}

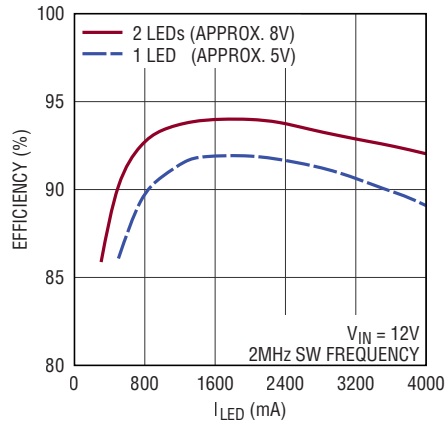

3935 G32

Regulated FB Voltage

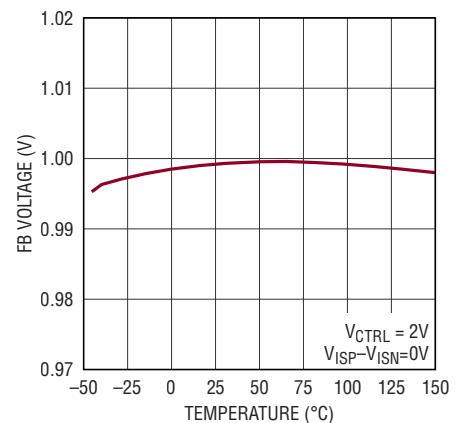

3935 G33

Input Voltage Transient Response

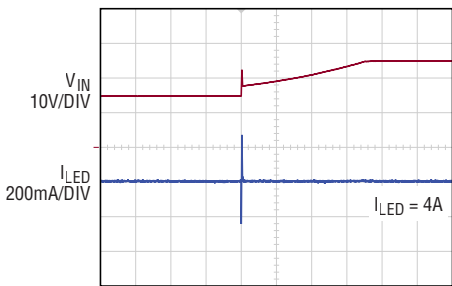

3935 G34

FRONT PAGE APPLICATION
15V TO 25V INPUT VOLTAGE STEP
3 LEDs (APPROX. 9V)

Input Voltage Transient Response

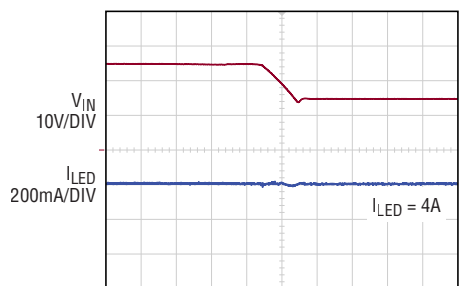

3935 G35

FRONT PAGE APPLICATION
25V TO 15V INPUT VOLTAGE STEP
3 LEDs (APPROX. 9V)

Turn-On and Turn-Off

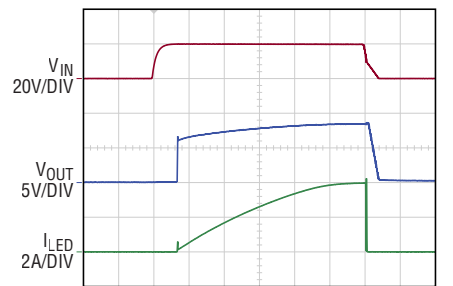

3935 G36

FRONT PAGE APPLICATION
3 LEDs (APPROX. 9V)
— data0

PIN FUNCTIONS

V_{IN}: Input Voltage Pins. These pins supply power to the internal, high performance analog circuitry, and they supply the inductor current when the internal high side power switch is on. Connect capacitors between these pins and GND and see Selecting and Placing the Input Capacitors in Applications Information for advice regarding their placement.

EN/UVLO: Enable and Undervoltage Lockout Pin. A voltage at this pin greater than 1.16V will enable switching, and a voltage less than 300mV is guaranteed to shut down the internal current bias and sub-regulators. A resistor network between this pin and GND can be used to set the pin voltage and automatically lockout the part when V_{IN} is below a certain level. No internal components pull up or down on this pin, so it requires an external voltage bias for normal operation. This pin may be tied directly to V_{IN}.

INTV_{CC}: Internally Regulated, Low-Voltage Supply Pin. This pin provides the power for the converter switch gate drivers. Do not force any voltage on this pin, but bypass it with a 2.2μF capacitor to GND.

ISP: Positive Current Sense Pin. This pin is one of the inputs to the internal current sense error amplifier. It should be connected to the positive side of the external sense resistor.

ISN: Negative Current Sense Pin. This pin is one of the inputs to the internal current sense error amplifier. It should be connected to the negative side of the external sense resistor.

ISMON: Output Current Monitoring Pin. This pin provides a buffered voltage output equal to 10mV for every 1mV between ISP and ISN.

CTRL: Control Pin. An analog voltage from 250mV to 1.25V at this pin programs the regulated voltage between ISP and ISN (and therefore, the regulated current supplied to the load). Alternatively, a digital pulse at this pin with duty cycle from 12.5% to 62.5% can be used to program the regulated voltage. Below 200mV or 10% duty cycle, the CTRL pin voltage disables switching. For more detail, see Regulated LED Current in Typical Performance Curves and Programming LED Current with the CTRL Pin in Applications Information.

V_{REF}: Reference Voltage Pin. This pin provides a buffered 2V reference capable of 2mA drive. It can be used to supply resistor networks for setting the voltages at the CTRL and PWM pins. Bypass with a 2.2μF capacitor to GND.

FB: Feedback Pin. When the voltage at this pin is near 1V, the regulated current is automatically reduced from the programmed value. A resistor network between this pin and V_{OUT} can be used to set a limit for the output voltage. If the voltage at the FB pin reaches 1.05V, an overvoltage lockout comparator disables switching.

FAULT: Fault Pin. Connect to INTV_{CC} through a resistance of 100k. When the FB pin voltage is less than 200mV, an internal switch pulls this pin low to indicate a short-circuit. When FB is greater than 950mV and the voltage between ISP and ISN is simultaneously less than 10mV, the switch pulls this pin low to indicate an open-circuit.

SS: Soft-Start Pin. At startup and recovery from fault conditions, a 20μA current charges the capacitor and the FB voltage tracks the rising voltage at this pin until the load current reaches its programmed level. Typical values for the capacitor are 10nF to 100nF. A resistor from SS to INTV_{CC} is used to select one of several fault modes. See Soft-Start and Fault Modes in Applications Information for more details.

V_C: Compensation Pin. A capacitor connected from this pin to GND stabilizes the current and voltage regulation. See Stabilizing the Regulation Loop in the Applications Information section for more details.

SW: Switch Pins. These two pins are internally connected to the power devices and drivers. They should always be tied together. In normal operation, the voltage of these pins will switch between the input voltage and zero at the programmed frequency. Do not force any voltage on these pins.

RT: Timing Resistor Pin. A resistor from this pin to GND programs the switching frequency between 200kHz and 2MHz. Do not leave this pin open.

PIN FUNCTIONS

SYNC/SPRD: Synchronization Pin. To override the programmed switching frequency, drive this pin with an external clock having a frequency between 200kHz and 2MHz. Even when using the external clock, select an R_T resistor that corresponds to the desired switching frequency. Tie the pin to $INTV_{CC}$ to enable spread spectrum frequency modulation. This pin should be tied to GND when not in use.

BST: Boost Pin. This pin supplies the high side power switch driver. Connect a 100nF capacitor between this pin and SW. An internal charge pump from $INTV_{CC}$ to BST will charge the capacitor when the SW pin is low.

PWM: PWM Input Pin. With the RP pin tied to GND, tie this pin to V_{REF} or $INTV_{CC}$ pin when PWM dimming is not required.

RP: PWM Resistor Pin. Tie this pin to GND.

V_{OUT}: Tie this pin to the output voltage even if dimming is not required.

GND: Ground Pins. These must be soldered to the ground plane of the circuit board.

NC: No Connection Pins.

BLOCK DIAGRAM

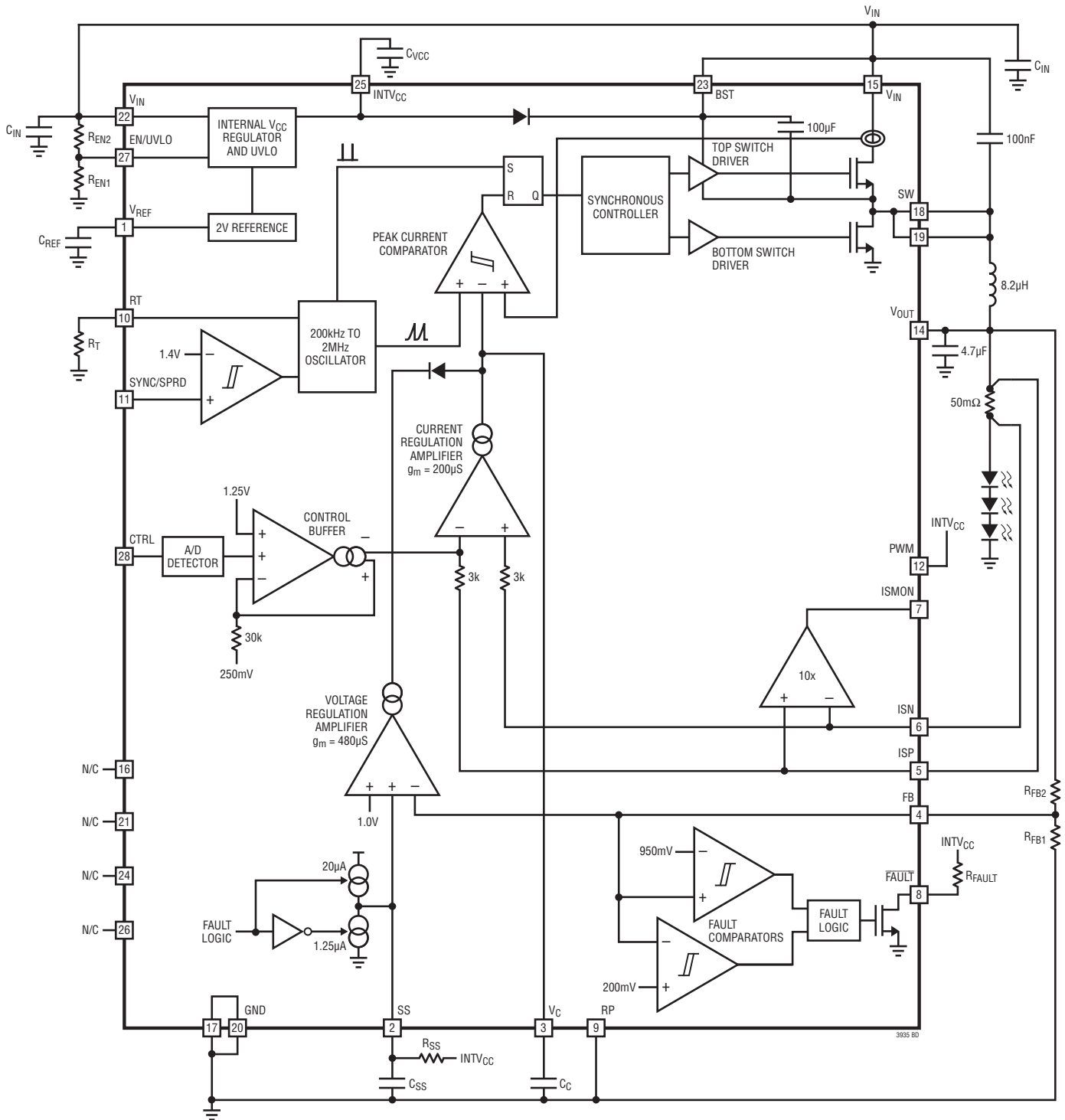

OPERATION

The LT3935 is a step-down LED driver that utilizes fixed-frequency, peak-current control to accurately regulate the current through a string of LEDs. It includes two power switches, their drivers, and a charge pump for providing power to the top switch driver. The switches connect an external inductor at the SW pin alternately to the input supply and then to ground. The inductor current rises and falls accordingly and the peak current can be regulated by adjusting the duty ratio of the power switches through the combined effect of the other circuit blocks.

The synchronous controller ensures the power switches do not conduct at the same time, and a programmable oscillator turns on the top switch at the beginning of each switching cycle. The frequency of this oscillator is set by an external resistor at the RT pin and can be overridden by external pulses at the SYNC/SPRD pin. The SYNC/SPRD pin can also be used to command spread spectrum frequency modulation (SSFM), which reduces radiated and conducted electromagnetic interference (EMI).

The top switch is turned off by the peak current comparator which waits during the on-time for the increasing inductor current to exceed the target set by the voltage at the V_C pin. This target is modified by a signal from the oscillator which stabilizes the inductor current. A capacitor at the V_C pin is necessary to stabilize this regulation loop.

The target for the inductor current is derived from the desired LED current programmed by the voltage at the CTRL pin. The analog-to-digital detector and the control buffer convert either a DC voltage or digital pulses at the CTRL pin into the input for the current regulation amplifier. The other input to this amplifier comes from the ISP and ISN pin voltages. An external current sense resistor between these pins should be placed in series with the string of LEDs such that the voltage across it provides the feedback to regulate the LED current. The current regulation amplifier then compares the actual LED current to the programmed LED current and adjusts V_C as necessary.

The voltage regulation amplifier overrides the current regulation amplifier, when the FB pin voltage approaches an internal 1V reference. An external resistor network from the LED string to the FB pin provides an indication of the LED string voltage and allows the voltage amplifier to prevent overvoltage of the LED string.

The FB voltage is also monitored to detect fault conditions like open and short-circuits, which are then reported by pulling the $\overline{\text{FAULT}}$ pin low. The response to a fault can be selected either to try hiccup restarts or to latch-off by the choice of an external resistor connected to the SS pin. Refer to Applications Information for a detailed explanation of fault responses.

APPLICATIONS INFORMATION

Use the following guide to configure the LT3935 according to your application requirements and to select the appropriate external components.

Programming LED Current with the CTRL Pin

The primary function of the LT3935 is to regulate the current for a string of LEDs. This current should pass through a series current sense resistor that can be placed anywhere in the string. Then the voltage across this resistor will be sensed by the current regulation amplifier through the ISP and ISN pins and regulated to a level programmed by the CTRL pin. The maximum resistor voltage that can be programmed is 100mV, which corresponds to 4A through the LED string when a 25mΩ current sense resistor is used.

To allow for this maximum current, the CTRL pin may be connected directly to the V_{REF} pin, which provides an accurate 2V reference. Lower current levels can be programmed by DC CTRL voltages between 250mV and 1.25V as shown in Figure 1.

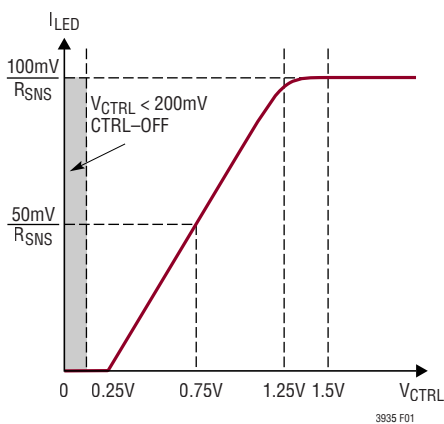

Figure 1. Analog CTRL Range

Below 250mV, the CTRL pin commands zero LED current, and above 1.25V, it commands the maximum. When an independent voltage source is not available, the intermediate CTRL voltages may be derived from the 2V reference at the V_{REF} pin using a resistor network or potentiometer as long as the total current drawn from the V_{REF} pin is less than 1mA.

Additionally, the LT3935 is capable of interpreting a pulse at the CTRL pin. The high level of the pulse must be greater than 1.6V. The low level must be less than 400mV. The frequency must be greater than 100kHz and less than 1MHz. Then the regulated voltage between ISP and ISN will vary with the duty ratio of the pulse as shown in Figure 2.

In this case, the LED current is zero for duty ratios less than 12.5% and reaches its maximum above 62.5%. The LT3935 will cease switching if the duty ratio of the CTRL pin pulse is less than 10%, and also for DC CTRL pin voltages less than 200mV.

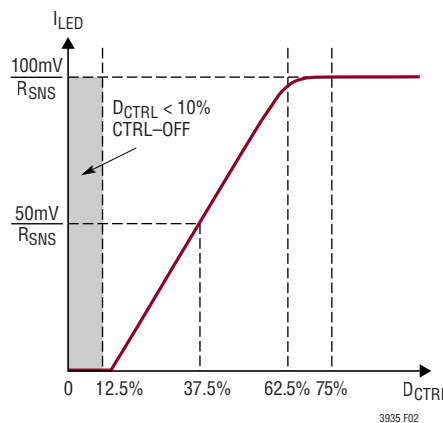

Figure 2. Duty Ratio CTRL Range

To reduce the LED current when the temperature of the LEDs rises, use resistors with negative temperature coefficient (NTC) in the network from V_{REF} to CTRL as shown in Figure 3.

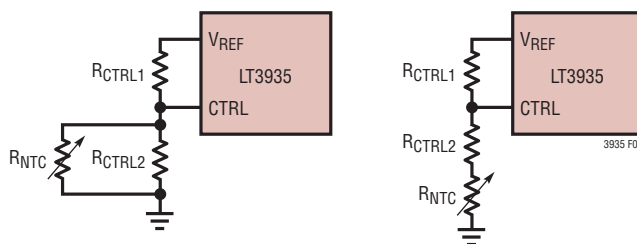

Figure 3. Setting CTRL with NTC Resistors

APPLICATIONS INFORMATION

Setting Switching Frequency with the RT Pin

The switching frequency of the LT3935 is programmed by a resistor connected between the RT pin and GND. Values of the R_T resistor from 45.3k up to 523k program frequencies from 2MHz down to 200kHz as shown in Table 1. Higher frequencies allow for smaller external components but increase switching power losses and radiated EMI.

Table 1. R_T Resistance Range

SWITCHING FREQUENCY	R_T
2.0MHz	45.3k
1.6MHz	59.0k
1.2MHz	80.6k
1.0MHz	97.6k
750kHz	133k
500kHz	205k
400kHz	255k
300kHz	348k
200kHz	523k

Synchronizing Switching Frequency

The switching frequency can also be synchronized to an external clock connected to the SYNC/SPRD pin. The high level of the external clock must be at least 1.4V, and the frequency must be between 200kHz and 2MHz. The R_T resistor is still required in this case, and the resistance should correspond to the frequency of the external clock. If the external clock ever stops, the LT3935 will rely on the R_T resistor to set the frequency.

Enabling Spread Spectrum Frequency Modulation

Connecting SYNC/SPRD to INTV_{CC} will enable spread spectrum frequency modulation (SSFM). The switching frequency will vary from the frequency set by the R_T resistor to 125% of that frequency. If neither synchronization nor SSFM is required, connect SYNC/SPRD to GND.

As shown in Figure 4, enabling SSFM can significantly attenuate the electromagnetic interference that the LT3935, like all switching regulators, emits at the switching frequency and its harmonics. This feature is designed to help devices that include the LT3935 perform better in the various standard industrial tests related to interference.

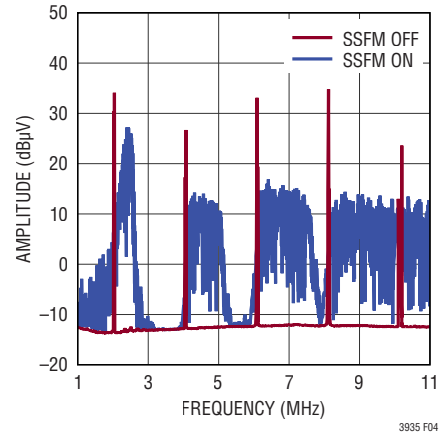

Figure 4. Typical Average Conducted Emissions

The attenuation varies depending on the chosen switching frequency, the range of frequencies in which interference is measured, and whether a test measures peak, quasi-peak, or average emissions. The results of several other such emission measurements are included with select Typical Applications.

Understanding the Current Limit

The choice of switching frequency should be made knowing that, although the maximum LED current that can be programmed with the CTRL pin is 4A, the inductor current may exceed 4A when the frequency is high and the output voltage is low as in a short-circuit. This is because there is a minimum on-time for which the SW pin will be driven high during each switching period. The inductor current increases during this time, and if the frequency is high and the output voltage low, there may not be enough off-time remaining in each switching period for the inductor current to decrease back to the level at which it started. In this case, the net inductor current would increase with each switching period regardless of the state of the CTRL pin.

To prevent large inductor currents that would damage the LT3935, the high-side switch is not turned on until the inductor current decreases to less than the inductor “valley” limit (called the DA limit), which is approximately 6.4A. The peak inductor current may increase to 6.8A, but the off-time and the switching period are extended until the inductor current reaches equilibrium as shown in Figure 5.

APPLICATIONS INFORMATION

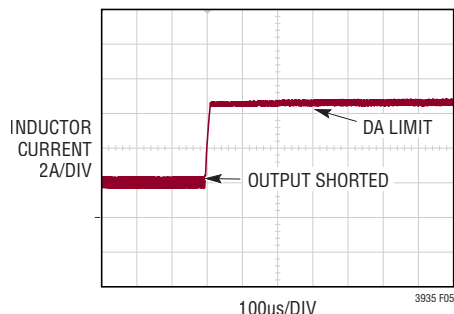

Figure 5. Extended Off-Time at Current Limit

The DA limit is relevant only when the output is shorted to GND. When the LED string is shorted to GND, the voltage across is high enough that the required on-time is greater than the minimum on-time. This means that, in spite of a shorted LED string, the inductor current remains in regulation even at the highest switching frequency.

Selecting an Inductor

The inductor must be rated for the current limit regardless of the intended application. Its value, in most applications, should be selected such that the inductor current ripple is not more than 25% of the maximum output current. When that current is 4A, for example, the minimum inductance can be calculated using the following equation:

$$L = 1\mu\text{H} \cdot \frac{V_{\text{OUT}}}{V_{\text{IN(MAX)}}} \cdot \frac{V_{\text{IN(MAX)}} - V_{\text{OUT}}}{1\text{V}} \cdot \frac{1\text{MHz}}{f_{\text{SW}}}$$

However, for high output voltages even the above equation would suggest an inductance value that is too small. For stability, the LT3935 requires an inductance greater than:

$$L = \frac{1\mu\text{H}}{3} \cdot \frac{V_{\text{OUT}}}{1\text{V}} \cdot \frac{1\text{MHz}}{f_{\text{SW}}}$$

Choose the larger of the values given by these equations. The manufacturers featured in Table 2 are recommended sources of inductors.

Table 2. Inductor Manufacturers

MANUFACTURER	WEBSITE
Würth Elektronik	www.we-online.com
Coilcraft	www.coilcraft.com

Selecting an Output Capacitor

Some applications are sensitive to ripple current in the LED string. In those cases, a capacitor at the output will absorb part of the inductor current ripple and thereby reduce the LED current ripple. Typically, the value of this capacitance is inversely proportional to the switching frequency and the output voltage as shown below:

$$C_{\text{OUT}} = 100\mu\text{F} \cdot \frac{1\text{V}}{V_{\text{OUT}}} \cdot \frac{1\text{MHz}}{f_{\text{SW}}}$$

However, applications may still be stable with more or less capacitance, and more capacitance may improve LED current waveforms.

Use X7R or X5R ceramic capacitors as they retain their capacitance better than other capacitor types over a wide voltage and temperature range. Sources of quality ceramic and electrolytic capacitors are listed in Table 3.

Table 3. Capacitor Manufacturers

MANUFACTURER	WEBSITE
Murata Manufacturing	www.murata.com
Garrett Electronics	www.garrettelec.com
AVX	www.avx.com
Nippon Chemi-Con	www.chemi-con.co.jp

Stabilizing the Regulation Loop

Stabilizing the regulation loop typically requires only a capacitor C_C connected from the V_C pin to GND. For most designs, values between 1nF and 10nF are suitable. When using an output capacitor C_{OUT} larger than 10 μF , a resistor R_C in series with C_C is also necessary. Larger values of C_{OUT} require larger values of R_C . See Typical Applications for some examples.

Selecting and Placing the Input Capacitors

Although they do not impact stability, several capacitors are necessary between V_{IN} and GND to properly bypass the input supply voltage. At least 10 μF is required in total, although it does not have to be composed entirely of ceramic capacitors placed very close to the V_{IN} pins. However, it is important that a ceramic capacitor be placed as close

APPLICATIONS INFORMATION

as possible to each of the pairs of V_{IN} pins (Pins 15 and 22) and their adjacent GND pins as shown in Figure 6. These two capacitors should be at least 0.1 μ F if possible. The V_{IN} pins can be jointed together using a trace on the second layer of the circuit board.

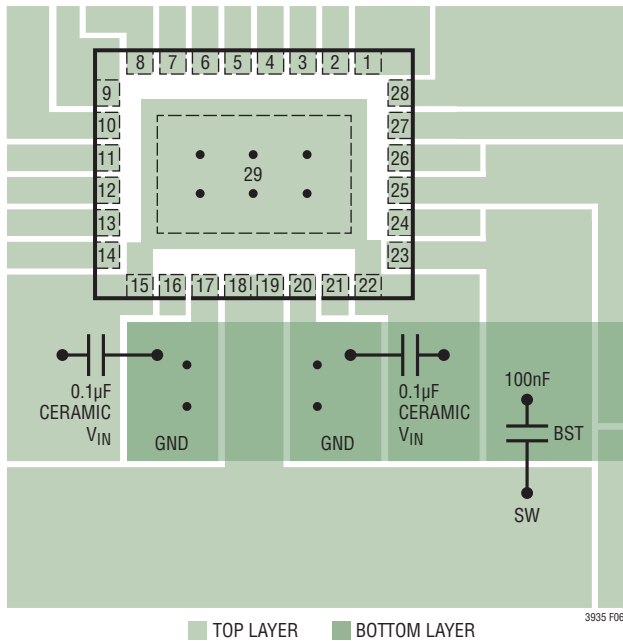

Figure 6. Placement of Input Capacitors

Monitoring LED Current

The ISMON pin provides an amplified and buffered monitor of the voltage between the ISP and ISN pins. The gain of the internal amplifier is ten, and the speed is fast enough to track the pulse-width modulated LED current. However, as shown in Figure 7, the ISMON voltage can be filtered with a resistor-capacitor network to monitor the average LED current instead.

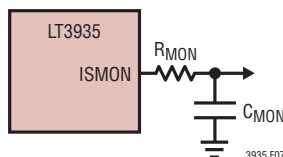

Figure 7. ISMON Filter Configuration

The resistor should be 1M Ω . The capacitance can be as large or small as needed without affecting the stability of the internal amplifier. For example, when the PWM frequency is 200Hz, a 100nF capacitor combined with the 1M Ω resistor would limit the ripple on ISMON to 1%.

Selecting the FB Resistors

Two resistors should be selected to form a network between the output voltage and the FB pin as shown in Figure 8.

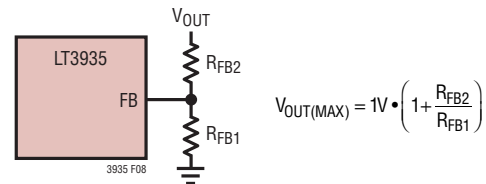

Figure 8. FB Resistor Configuration

This network forms part of a voltage regulation loop when FB is nearly 1V. In this case, the LT3935 will override the programmed LED current to lower the output voltage and limit FB to 1V. This resistor configuration therefore determines the maximum output voltage.

Note that this voltage limit may be reached inadvertently if it is set too close to the typical output voltage and the output capacitor is too small. To avoid interference with the current regulation, the feedback resistors should be chosen such that FB is about 700mV when the LEDs are conducting.

For a 12V string of LEDs, design for a maximum output voltage of about 17V. Start with a 10k resistor for R_{FB1} . To calculate the value of R_{FB2} , add 10k for every volt of difference between FB (1V) and the maximum output voltage. In this case, the nearest standard 1% value for R_{FB2} would be 162k.

In this way, the LT3935 can also be configured as a voltage regulator instead of an LED driver. It will regulate the output voltage near the programmed maximum as long as the load current is less than the current level programmed by CTRL.

APPLICATIONS INFORMATION

Understanding FB Overvoltage Lockout

It is possible that the FB voltage can exceed the 1V limit. If the output voltage is near the maximum when the LED string opens, it may take too long for the feedback loop to adjust the inductor current and avoid overcharging the output. However, if the FB voltage exceeds the 1.05V Overvoltage Lockout Threshold, the LT3935 will immediately stop switching and resume only when FB decreases to 1V.

This threshold may be routinely exceeded when the LT3935 is being operated as a voltage regulator and the load current decreases rapidly. In this case, the pause in switching limits the output overshoot and ensures that the voltage is back in regulation as quickly as possible. For safe operation, choose R_{FB2} and R_{FB1} values to ensure the output voltage is not greater than V_{IN} when the FB voltage is 1.05V.

Open and Shorted LED Fault Detection and Response

The resistor network formed by R_{FB1} and R_{FB2} also defines the criteria for two fault conditions with respect to the LED string: short and open-circuits. For the LT3935, a short-circuit is when FB is less than 200mV. An open-circuit is when FB is greater than 950mV and simultaneously the difference between ISP and ISN is less than 10mV (the C/10 threshold). The latter condition ensures that the output current is low (as it should be in an open-circuit) not just that output voltage is high as it may be when the LEDs are conducting a large current.

In both cases, a fault is indicated by an internal device pulling the voltage at the $\overline{\text{FAULT}}$ pin low. There is nothing internal that pulls this voltage high, so an external resistor between INTV_{CC} and $\overline{\text{FAULT}}$ is necessary as shown in Figure 9. This configuration allows multiple $\overline{\text{FAULT}}$ pins and similar pins on other parts to be connected and share a single resistor.

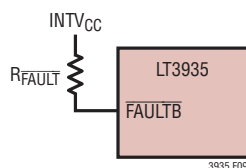

Figure 9. $\overline{\text{FAULT}}$ Resistor Configuration

Soft-Start and Fault Modes

The SS pin has two functions. First, it allows the user to program the output voltage startup ramp rate. An internal 20 μ A current pulls up the SS pin to INTV_{CC} . Connecting an external capacitor C_{SS} from the SS pin to GND, as shown in Figure 10, will generate a linear ramp voltage. The LT3935 regulates the FB pin voltage to track the SS pin voltage until V_{OUT} is high enough to drive the LED at the commanded current level.

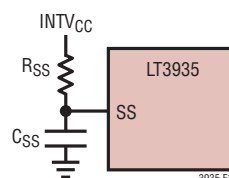

Figure 10. SS Capacitor and Resistor Configuration

The SS pin is also used as a fault timer. After a fault is detected, an internal 1.25 μ A current sink will begin to discharge the soft-start capacitor and lower the voltage at the SS pin. When the voltage falls from 3.3V to 1.7V, all switching will cease, but the SS pin will continue to discharge. Switching will not resume until SS reaches 200mV. At this point, the 20 μ A current will recharge the soft-start capacitor, and the LT3935 will try to switch again. If the fault persists when SS returns to 1.7V, the process will repeat as shown in Figure 11.

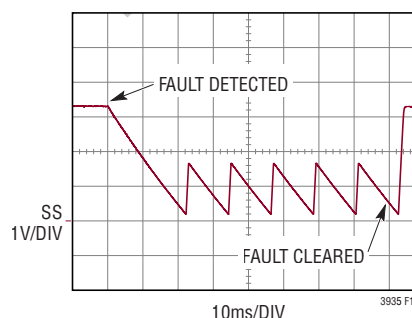

Figure 11. Hiccup Response to Fault

APPLICATIONS INFORMATION

The charging rate of the soft-start capacitor is much faster than the discharging rate, so while the fault persists, the LT3935 will only attempt switching for a relatively short part of the cycle before being interrupted. Although the LT3935 can safely endure a short-circuit while continuously switching, this hiccup action saves power. The frequency of the hiccups is inversely proportional to C_{SS} and 100nF yields about 8Hz.

The operating point of a voltage regulator supplying light loads will frequently satisfy the criteria for an open-circuit, and the hiccup behavior would therefore be very disruptive. So when the LT3935 is configured as a voltage regulator, a resistor R_{SS} should be connected between $INTV_{CC}$ and SS as shown in Figure 10.

The current that pulls down the SS pin during a fault is so weak that if R_{SS} is 1M Ω , the voltage at the SS pin will never reach 1.7V. Therefore, the LT3935 will not stop switching or start to hiccup. With this resistor, the LT3935 will continue switching and rely on overvoltage and overcurrent protection to guarantee safe operation in the event of open-circuits and short-circuits.

If the resistor is changed to 2M Ω , then the SS pin may be discharged to less than 1.7V, but not less than 200mV as shown in Figure 12. The LT3935 will consequently cease switching permanently until being reset by the EN/UVLO pin or by powering off. Some applications may demand this behavior so that short and open-circuits can be investigated manually before resuming normal operation.

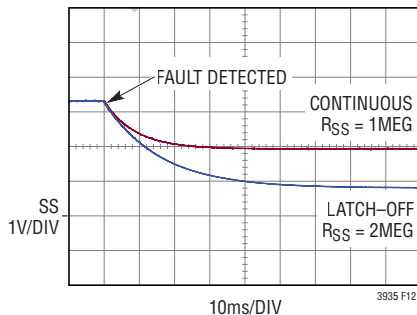

Figure 12. Latch-Off Response to a Fault

This latch-off behavior is the third of three ways that the LT3935 can be programmed to respond to faults—the other two being continuous operation and the default hiccup behavior.

Programming the EN/UVLO Threshold

An external voltage source can be used to set the voltage at the EN/UVLO pin to enable or disable the LT3935. The LT3935 will stop switching, and reset the SS pin when the voltage at EN/UVLO drops below 1.16V, but internal circuitry will continue drawing current. Full shutdown is guaranteed when EN/UVLO is below 300mV, and in full shutdown the LT3935 will draw less than 16 μ A. For applications in which the level of the source driving EN/UVLO changes slowly, 20mV of hysteresis has been added to the 1.16V enable threshold.

Alternatively, a resistor network can be placed between V_{IN} and EN/UVLO as shown in Figure 13. In this case, EN/UVLO automatically falls below 1.16V and disables switching when V_{IN} falls below a certain level, called the Undervoltage Lockout (UVLO) threshold, which is defined by resistors R_{EN1} and R_{EN2} . Additionally, a 4 μ A current is designed to flow into EN/UVLO when the pin voltage is below the threshold. This current provides additional hysteresis. To define the hysteresis (V_{HYST}) and the UVLO threshold (V_{UVLO}) select R_{EN1} and R_{EN2} according to the following equations:

$$R_{EN2} = \frac{V_{HYST}}{4\mu A} - \frac{V_{UVLO}}{480\mu A}$$

$$R_{EN1} = \frac{1.16 \cdot R_{EN2}}{V_{UVLO} - 1.16}$$

For example, to program a 10V threshold with 1V of hysteresis, use 226k and 29.4k for R_{EN2} and R_{EN1} , respectively.

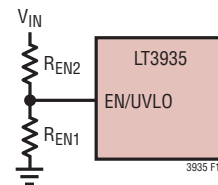

Figure 13. EN/UVLO Resistor Configuration

APPLICATIONS INFORMATION

Planning for Thermal Shutdown

The LT3935 automatically stops switching when the internal temperature is too high. The temperature limit is guaranteed to be higher than the operational temperature of the part. During thermal shutdown, all switching is terminated, SS is forced low, and the LEDs are off.

The exposed pad on the bottom of the package must be soldered to a ground plane. Vias placed directly under the package are necessary to dissipate heat.

Following these guidelines, the official four-layer demo board DC2987A reduces the thermal resistance, θ_{JA} to 27°C/W. With a compromised board design, θ_{JA} could be 40°C/W or higher.

Designing the Printed Circuit Board

Note that large switched currents flow through the local input capacitors and the V_{IN} and GND pins. The loops traveled by these currents should be made as small as possible by keeping the capacitors as close as possible to these pins. These capacitors, as well as the inductor, should be placed on the same side of the board as the LT3935 and connected on the same layer. Other large, bulk input capacitors can be safely placed farther from the chip and on the other side of the board.

Create a Kelvin ground network by keeping the ground connection for all of the other components separate. It should only join the ground for the input and output capacitors and the return path for the LED current at the exposed pad.

There are a few other aspects of the board design that improve performance. An unbroken ground plane on the second layer dissipates heat, but also reduces noise. Likewise minimizing the area of the SW and BST nodes reduces noise. The traces for FB and V_C should be kept short to lessen the susceptibility to noise of these high impedance nodes. Matched kelvin connections from the external current sense resistor R_S to the ISP and ISN pins are essential for current regulation accuracy. The 2.2 μ F $INTV_{CC}$ and V_{REF} capacitors as well as the 100nF BST capacitor should be placed as closely as possible to their respective pins. A capacitor for the CTRL pin should be placed near the pin for analog dimming. The PWM pin can be tied to V_{REF} or $INTV_{CC}$. Please refer to the demo board layout of the LT3935 for an example of how to implement these recommendations.

TYPICAL APPLICATIONS

4A LED Driver with Analog CTRL Current

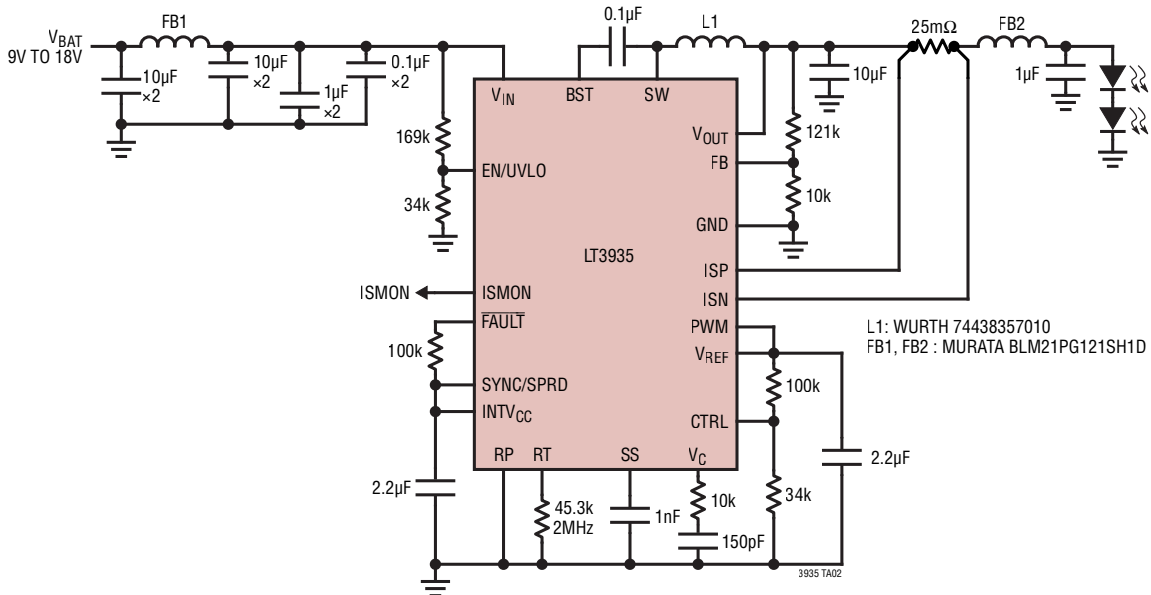

CISPR25 Peak Conducted EMI Performance

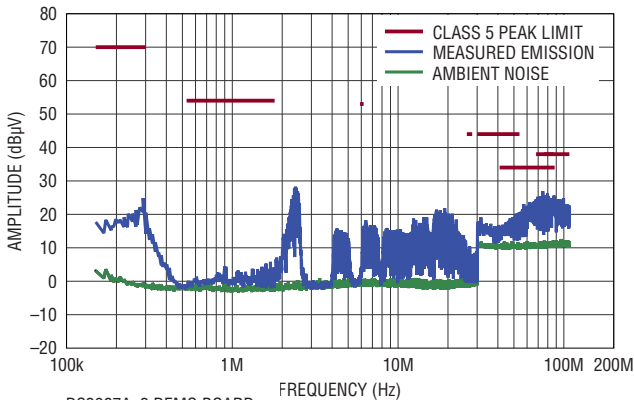

DC2987A-2 DEMO BOARD
12V INPUT TO 6.7V OUTPUT AT 1.5A, $f_{SW} = 2\text{MHz}$

3935 TA02a

CISPR25 Peak Radiated EMI Performance

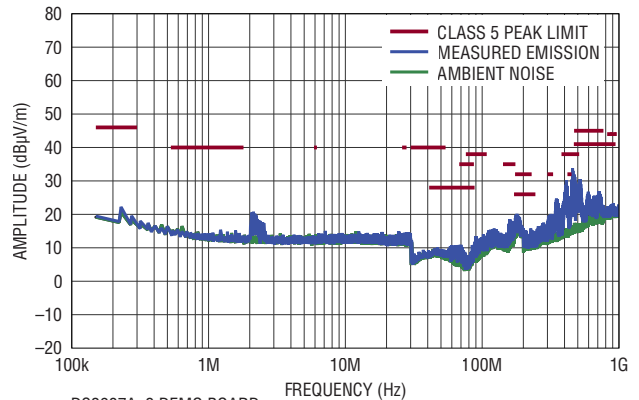

DC2987A-2 DEMO BOARD
12V INPUT TO 6.7V OUTPUT AT 1.5A, $f_{SW} = 2\text{MHz}$

3935 TA02b

CISPR25 Average Conducted EMI Performance

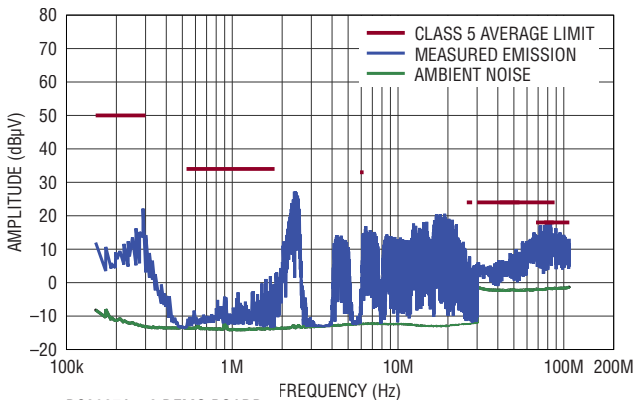

DC2987A-2 DEMO BOARD
12V INPUT TO 6.7V OUTPUT AT 1.5A, $f_{SW} = 2\text{MHz}$

3935 TA02c

CISPR25 Average Radiated EMI Performance

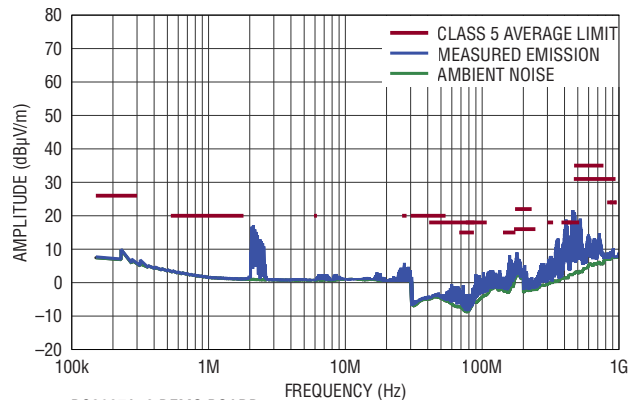

DC2987A-2 DEMO BOARD
12V INPUT TO 6.7V OUTPUT AT 1.5A, $f_{SW} = 2\text{MHz}$

3935 TA02d

REVISION HISTORY

REV	DATE	DESCRIPTION	PAGE NUMBER
0	11/21	Initial release	—
A	11/22	Updated Typical Application Circuit, Absolute Maximum Ratings, Electrical Characteristics, and Related Parts	1, 2, 4, 22

TYPICAL APPLICATION

1.5A LED Driver with Fault Indication

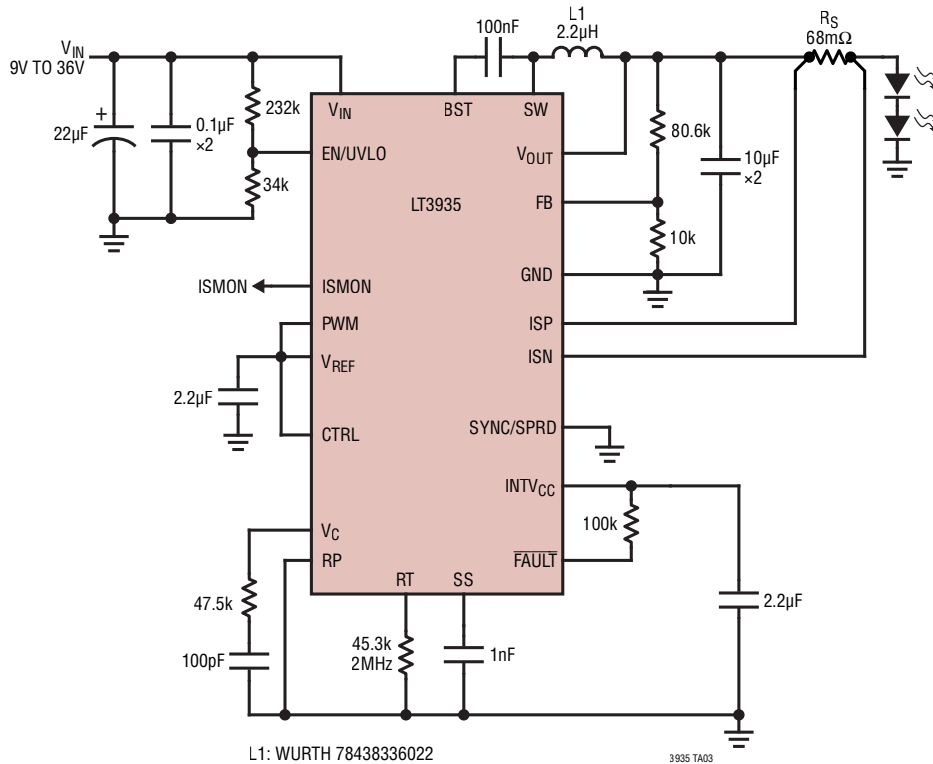

RELATED PARTS

PART NUMBER	DESCRIPTION	COMMENTS
LT3932/ LT3932-1	36V, 2A, 2MHz, Step-Down LED Driver	V_{IN} : 3.6V to 36V, $V_{OUT(MAX)}$ = 36V, 5000:1 True Color PWM Dimming, 4mm × 5mm QFN
LT8376	60V, 2A, 2MHz, Step-Down LED Driver	V_{IN} : 3.6V to 60V, $V_{OUT(MAX)}$ = 60V, 5000:1 True Color PWM Dimming, 4mm × 5mm QFN
LT3922/ LT3922-1	40V, 2.3A, 2MHz, Synchronous Boost LED Driver	V_{IN} : 2.8V to 36V, $V_{OUT(MAX)}$ = 40V, 5000:1 True Color PWM™ Dimming, 4mm × 5mm QFN
LT8386	60V, 3A, 2MHz, Synchronous Boost LED Driver	V_{IN} : 4V to 56V, $V_{OUT(MAX)}$ = 52V, 50,000:1 True Color PWM Dimming, 4mm × 5mm LQFN
LT3967	1.3A, 8-Switch Matrix LED Dimmer	V_{IN} : 8V to 60V, Digital Programmable 256:1 PWM Dimming, I ² C Multidrop Serial Interface TSSOP-28E Package
LT3950	60V, 1.5A, 2MHz, Step-Up/Down LED Driver	V_{IN} : 3V to 60V, $V_{OUT(MAX)}$ = 60V, 20,000:1 True Color PWM Dimming, MSOP-16E
LT3956	80V, 3.3A 1MHz, Step-Up/Down LED Driver	V_{IN} : 4.5V to 80V, $V_{OUT(MAX)}$ = 80V, 3000:1 True Color PWM Dimming, 5mm × 6mm QFN
LT3477	42V, 3A, 3.5MHz, Step-Up/Down LED Driver	V_{IN} : 2.5V to 25V, $V_{OUT(MAX)}$ = 40V, 4mm × 4mm QFN and TSSOP-20E
LT3478	42V, 4.5A, 2.5MHz, Step-Up/Down LED Driver	V_{IN} : 2.5V to 26V, $V_{OUT(MAX)}$ = 42V, 3000:1 True Color PWM Dimming, TSSOP-16E
LTM8040	36V, 1A, µModule, Step-Down LED Driver	V_{IN} : 4V to 36V, $V_{OUT(MAX)}$ = 13V, 250:1 True Color PWM Dimming, 9mm × 15mm × 4.32mm LGA
LTM8042	36V, 1A, µModule, Step-Up/Down LED Driver	V_{IN} : 3V to 30V, $V_{OUT(MAX)}$ = 36V, 3000:1 True Color PWM Dimming, 9mm × 15mm × 2.82mm LGA
LT3757	40V, 1MHz, Step-Up Controller	V_{IN} : 2.9V to 40V, Positive and Negative Output Voltages, 3mm × 3mm DFN and MSOP-10E